



MAGISTRA PLUS 700 - ELECTRICAL RANGES

MPQ74T



2 SQUARE PLATES TOP

TECHNICAL DATA:

External dimensions - WxDxH (cm)	40x71,4x25
Nr. Plates 2,6 kW	2
Total power (kW)	5,2

ADDITIONAL TECHNICAL DATA:

Supply (N)	400V 3N 50/60Hz
Weight (kg)	27
Volume (m3)	0,2

The cast iron fast-heating hot plates with safety device to prevent overheating are watertight fixed to the worktop. They are available in three versions: rounded with diameter 145/200 mm and power 1.5 kW and 2.6 kW; squared with dimension 220x220 mm and power 2,6 kW; lowered with dimension 300x300 mm and power 2,5 kW. Indicator lights show when each hotplate is working. 1 mm worktop in AISI 18/10 stainless steel. Excellent alignment with joints.

Versions with oven:

Stainless steel cooking chamber with enameled bottom, stainless steel double-wall door with insulating casing. Electric oven: 5.3 kW (2,6 kW for ventilated oven) stainless steel armoured heating elements placed on the bottom and on the top of the cooking chamber; thermostatic temperature control with separate bottom/top temperature control for maximum cooking flexibility. 3 GN 2/1 rack support (static oven) and 3 GN 2/1 rack support (ventilated oven).

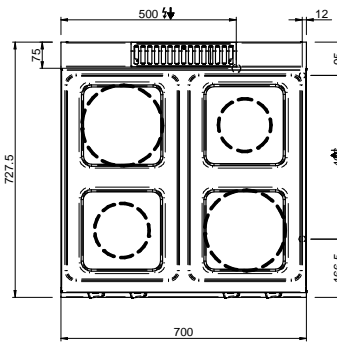
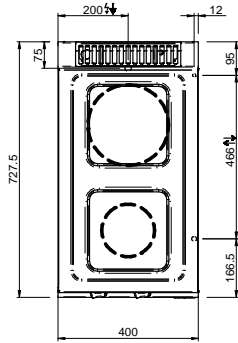
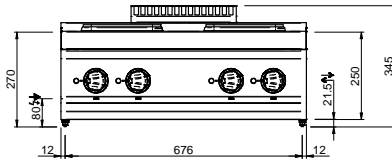
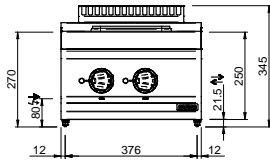

LEGENDA SIMBOLI / LEGEND



INGRESSO GAS / GAS INLET
(EN 10226-1) Ø M 1/2"



ALIMENTAZIONE ELETTRICA /
POWER SUPPLY



INGRESSO ACQUA /
WATER INLET Ø M 1/2"



SCARICO ACQUA / OLII
WATER / OILS DRAIN



ATTACCO EQUIPOTENZIALE /
EQUIPOTENTIAL



REGOLAZIONE PIEDINI /
FEET ADJUSTMENT (h 0/+5)